

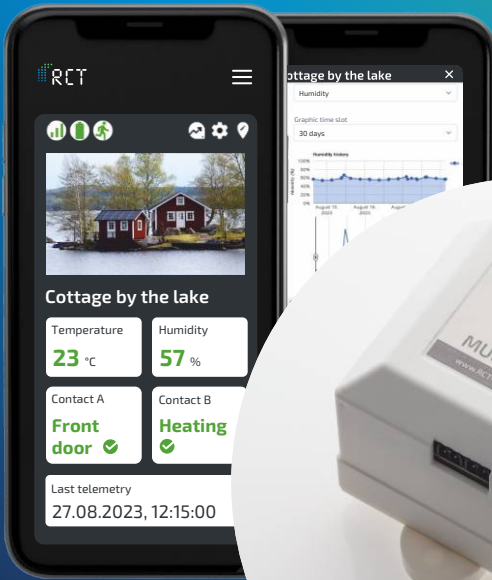

# MULTview

Mobile monitoring of rooms, objects  
and operating states

- Ideal for vacation homes, containers, warehouses, production halls, refrigeration rooms, trucks or mobile homes, garden and greenhouses
- Usable everywhere self-sufficiently without 230V power connection





## 5 conditions perfectly in view

### MOVEMENT

- High-sensitivity motion sensor | 360°  
e. g. interior monitoring, break-in



### TEMPERATURE

- Integrated temperature sensor  
-40 °C ... +125 °C |  $\pm 1$  °C  
e. g. to monitor heating and cooling  
systems or temperature sensitive  
outdoor applications



### HUMIDITY

- Integrated humidity sensor  
0 ... 100 % RH |  $\pm 4$  % RH  
e. g. monitoring greenhouses  
and warehouses



### A CHOICE OF 2 ALARMS

- Freely usable inputs for  
connecting potential free  
switches for alarms  
e. g. door and window contacts  
(break-in), heating and air condition  
failure, power outage and many more



### POWER FAILURE (available as accessory)

- Optional adapter for connecting an  
alarm contact with a 230 V power socket  
to detect a power outage



## MULTIview.

Your mobile monitoring solution for fast and easy remote monitoring: of rooms, objects and operating states.

### Simple. Mobile. Informed.

#### + SIMPLE PLUG-AND-PLAY

Wireless, battery powered\*, pre-configured with SIM card ready for immediate use.

#### + USABLE EVERYWHERE MOBILE AND FLEXIBLE

Receive measurement data and alarms conveniently on your smartphone, tablet or PC. Get important messages via push and mail.

#### + INFORMED RELIABLY

Periodical reporting of the current measured values. Alarms at individually definable limit values and events. History data and graphics of humidity and temperature.

\* Battery pack up to 2 years lifetime depending on transmitting frequency



RCT. Simplify monitoring.



## Everything under control on PC or mobile

All messages from the MULTview are sent directly to the RCT server and are available to you in full on your PC, smartphone or tablet: information on humidity, temperature and movement as well as alarms in case of an event or when limit values are reached.

### OVERVIEW

- Clear overview of current measured values and alarms

### COMPARISON

- Graphical or tabular presentation of history data

### INDIVIDUAL CUSTOMIZATION

- Simple self-explanatory configuration of limit values and alarm parameters

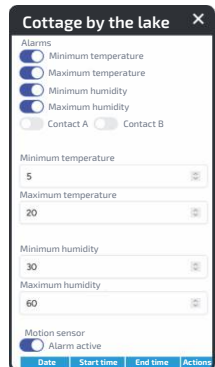
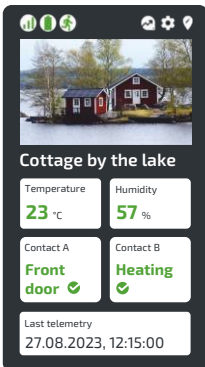

## And this is how it works

MULTIview can be used instantly in almost any location - even where no power connection is available. Simply place it in the detection area or attach it to the wall or ceiling using a magnetic holder.

### MOTION SENSOR DETECTION RANGE

- All-round detection: 360°
- Range: 2 m
- With wall mounting horizontal range: 12 m

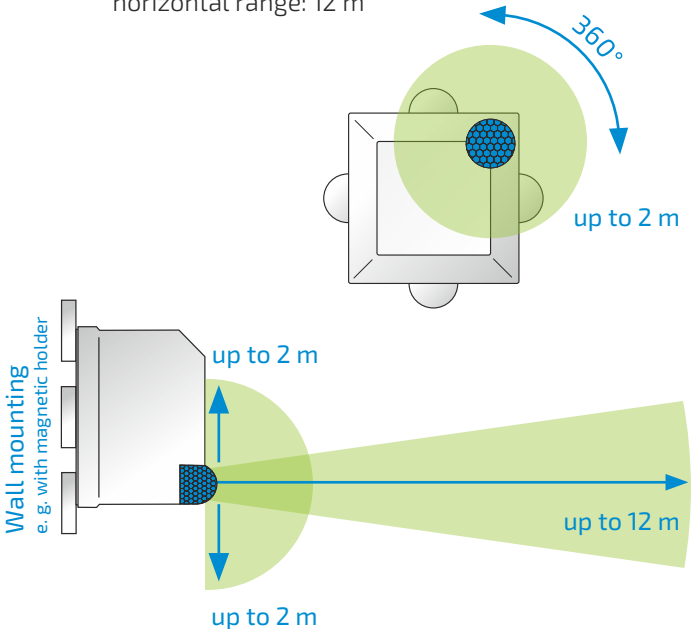



## Ready to use in just 3 steps

1

### SET UP VIA PC OR SMARTPHONE

- Open a web browser on a PC or mobile device and enter URL „**multiview.r-c-t.biz**“ in the address bar
- Register/log in user with mail address
- Register product using security key

2

### CONFIGURE INDIVIDUAL SETTINGS

- Enable/disable sensor messages
- Define limit values and alarm reasons
- Select transmission times for status messages and much more

3

### ACTIVATE MULTIVIEW

- Insert enclosed SIM card from RCT
- Attach MULTiview to battery pack = active
- Device retrieves set parameters
- Configured status messages and alarms are sent

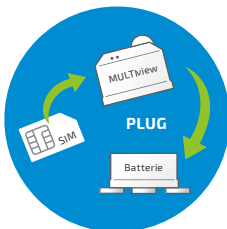

## Simply plug and play

### + **ACTIVATE OR PAUSE AS NEEDED**

Once set up, you can activate the MULTiView any-time and anywhere simply by plugging it to the battery or deactivate it by disconnecting. All settings remain stored while the unit waits for its next use. Or you can use the internal calendar to activate the MULTiView on specific days/times.

### + **FLEXIBLE RECEPTION**

The set contains a prepared SIM card from RCT in best Telekom network quality. No need to search for a suitable provider. Immediately usable. Data reception possible at any mobile device/PC with web access.

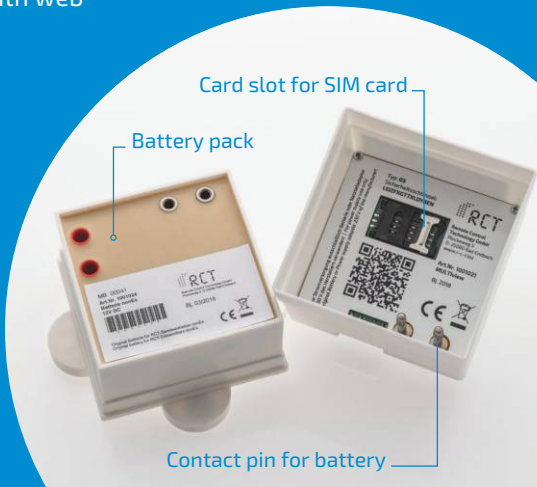



EXAMPLE OF USE

MULTIview - Ideal for properties that are temporarily unoccupied, such as a vacation or second residence, garden house or mobile home



**Heating failure**

via fault alarm contact

**Opening of door or window**

via door/window contact (accessory)

**Movement in the inside area**

in detection range

**Temperature and humidity**

status, history, alarm in case of exceeding/falling below limit values

**Power failure**

via power failure indicator (accessory)



# Heating failure and freezing risk in the vacation home?

The temperature is sub-zero and suddenly the heating breaks down? If no one notices, there is an enormous risk of damage, e.g. from frozen water pipes. Thanks to MULTiview, you know at an early stage and can take targeted preventive steps before it becomes expensive.

# Uninvited guests in the summer house or mobile home?

Whether it's a human or an animal - MULTiview informs you immediately when it detects movement indoors (in the detection area) or when a door or window contact is switched (accessory).

**Cottage by the lake**

Last telemetry  
05.09.2023,  
00:03:38  
(14 hours ago)

Status

Temperature  
**23°C**

Humidity  
**57%**

Contact A  
**Light garden** ✓

Contact B  
**Front door** ✓

Alarms in the last 2 days (0)

✓

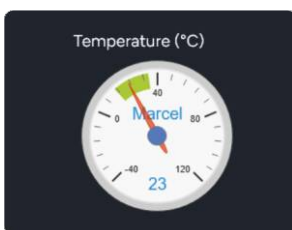



MULTIview - Ideal for trade, craft and transport businesses, e.g. for container, office room, green house, refrigeration room, transport vehicles

## News from the loading platform or the warehouse?

Whether it's a 40-ton truck, a refrigerated transporter or a craftsmen's vehicle: MULTIview keeps a constant eye on the load, machines and equipment and alerts immediately if anyone tries to steal something. The stored goods require a certain temperature and humidity? MULTIview warns you as soon as the set limit values are exceeded or not reached and automatically documents the history.

## It's too cold and too dry for your plants!

All-round ideal growing conditions for sensitive plants: With MULTIview, you can keep an eye on temperature and humidity. You are alerted when it is too cold, the air conditioning fails or if the windows should be opened due to overheating.



**Movement in the inside area**  
in detection range

**Opening of door or window**  
via door/window contact (accessory)

**Temperature and humidity**  
status, history, alarm in case of exceeding/falling below limit values

**Heating/air conditioning**  
via fault alarm contact

**Power failure**  
via power failure indicator (accessory)

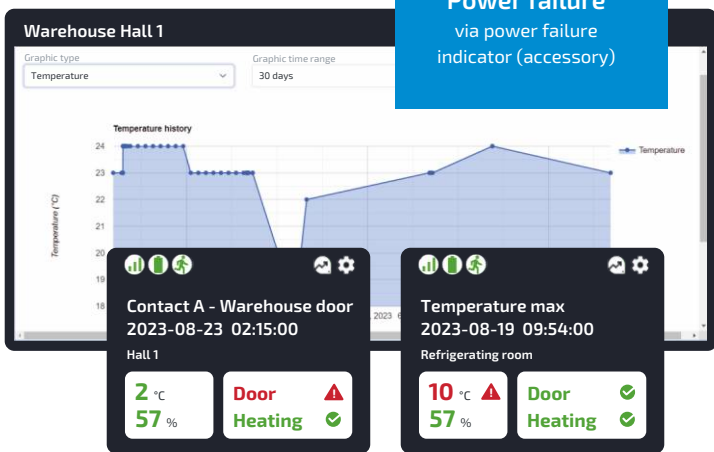



MULTIview - Ideal for caretaker services and facility management in public buildings and commercial properties

## Is everything working?

In a commercial building, a school or a public facility, the caretaker is not present on site at all times. If there is a problem with the heating, air conditioning or a technical system, or if there is even a power failure, MULTIview informs the responsible person directly and without delay so that measures can be taken immediately.



**Alarm in case of failures**

via fault alarm contact

**Alarm when limit values  
are reached**

**Automatic documentation of the  
history of all faults, operating  
states, temperatures and  
humidity**

Tank contents, meter readings,  
energy resources and consumptions?

More monitoring solutions on:  
[www.r-c-t.biz](http://www.r-c-t.biz)

## RCT LEVELview

With LEVELview,  
you can also easily  
keep an eye on  
the fill level of  
tanks, containing  
heating oil, liquid gas or  
water, via Web & App.

This enables you to know your  
energy reserves at all times and have your consump-  
tions precisely under control.



## RCT METERview

The stand-alone trans-  
mitter unit METERview  
can be easily retro-  
fitted to existing gas  
meters. In this way,  
not only the meter  
reading but also the  
consumption can be  
continuously and auto-  
matically documented as  
well as monitored and analyzed  
at any time via Web & App.



RCT. Simplify monitoring.



Notification parameter	Alarm on/off	Further setting options
Temperature -40 °C ... +125 °C	●	Min. + Max. limit value
Rel. humidity 0 ... 100 % rh	●	Min. + Max. limit value
Motion sensor	●	Time period for activity
External alarm 1 (contact)	●	
External alarm 2 (contact)	●	
Battery alarm	Always on	
Status notification	Individual transmitting interval	
Positioning	Triangulation via dial-in nodes	

## General technical specifications

Power supply	<ul style="list-style-type: none"> <li>• RCT Battery pack (inclusive)</li> <li>• alt. Power supply adapter 230 V for wired power supply (in accessories)</li> </ul>
Battery-lifespan	Up to 2 years, depending on frequency of notifications
Operating temperature	-10 °C to +40 °C
Construction	UV-resistant plastic housing
Dimensions	Approx. 107 x 107 x 80 mm (LxWxH)
Mounting	As required on the wall or ceiling with magnetic mount or 2 screws
Area of application	In enclosed rooms
Configuration	Via Web App on PC/mobile device

## Sending and Receiving

Data transfer	GPRS (GSM cellular standard)
SIM card (GSM)	Pre-configured standard SIM card (mini SIM 2FF), Telekom Deutschland mobile network, including 2 years of free use
Data reception	Web App on Smartphone/Tablet/PC



## Included in delivery

**1001027** MULTiview transmitter with RCT battery pack, magnetic wall mount, instruction manual, free use of the RCT Web App, pre-configured SIM card (mini SIM 2FF, Telekom Deutschland mobile network, including 2 years of free use)

Mobile phone, door/window contacts not included in delivery!

## Accessories

- |                |   |
|----------------|---|
| <b>1001028</b> | Replacement battery RCT nonEx                             |
| <b>1000878</b> | Power supply adapter 230 V (for wired power supply)       |
| <b>1001040</b> | Power failure indicator (for monitoring of power failure) |

## MULTiview complete set

including battery pack, SIM card and free data transfer for the first two years of use in the Telekom Deutschland mobile network as well as data provision via the RCT Web App „multiview.r-c-t.biz“.

After two years, an automatic query will be sent via the Web App: you can choose to continue using the included SIM card for EUR 49,- per year (including VAT) or to use your own SIM card from a provider of your choice (prepaid/contract).



**Immediately  
usable  
including  
SIM card and  
battery pack**

# 249,- EURO

*Gross price including VAT, shipping  
and 2 years of connectivity*



RCT. Simplify monitoring.



Your contact:

A large white rectangular area intended for contact information, currently blank.

**Remote Control Technology GmbH**

Turmstraße 15  
D-35075 Gladenbach

T +49 (0) 6462 419880  
F +49 (0) 6462 4198810

info@r-c-t.biz  
www.r-c-t.biz

Photos: RCT, Adobe Stock, Andy Alexander,  
Digital Fotogroup GmbH

© RCT 09.2023 | Subject to change!